

Handledare typ 21

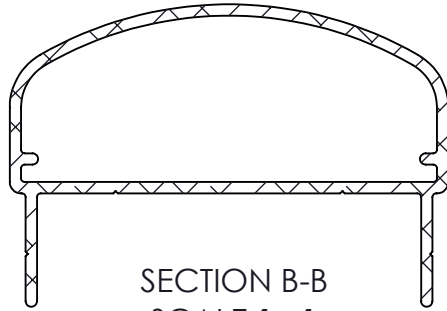

SECTION B-B
SCALE 1 : 1

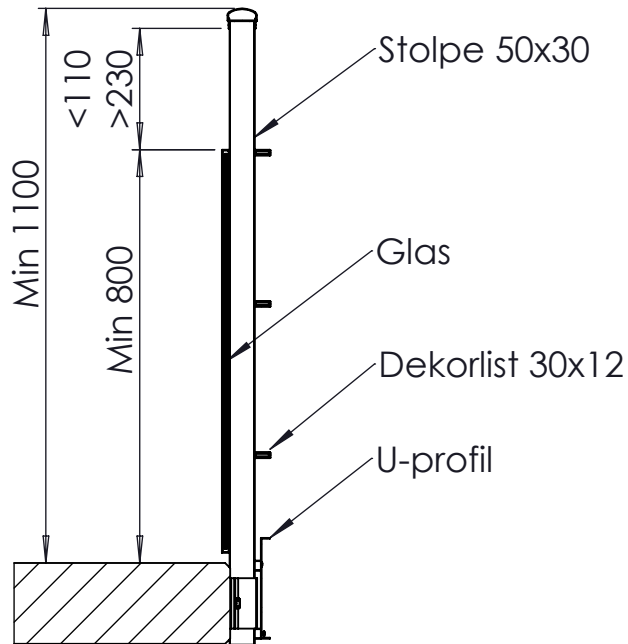
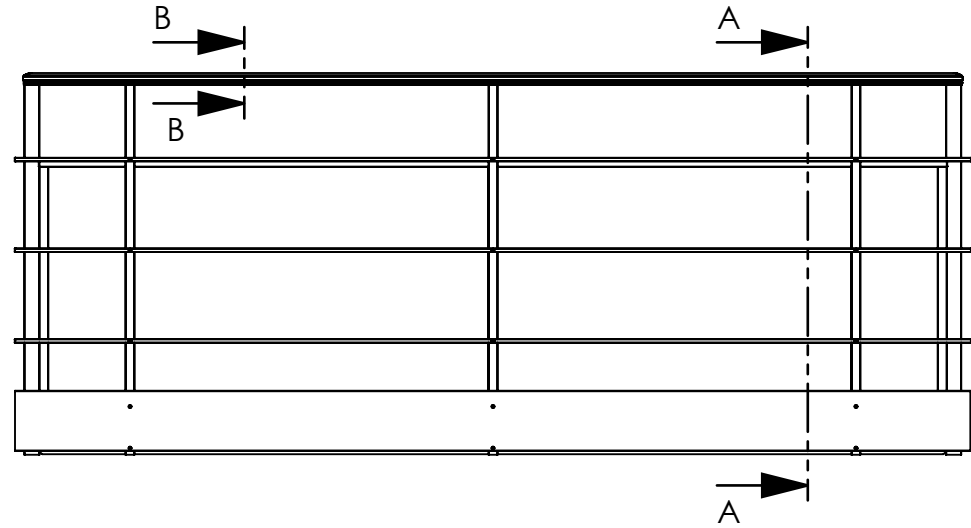

SECTION A-A
SCALE 1 : 15

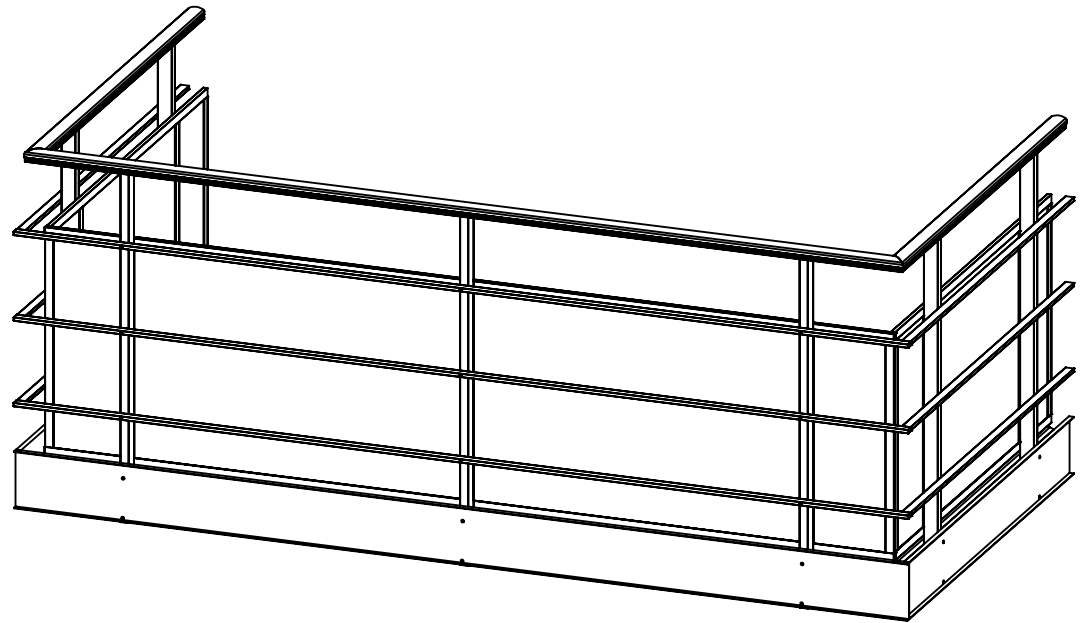

Konstr. EF	Ritad EF	Kop. -	Kontr. -	Stand. -	Godk.	Skala 1:25	Generell tolerans SS-ISO 2768-m		
						RT402 + Dekorlist 30x12 + U-profil		Ordernummer	Datum
						Björnstorpsvägen 2 342 30 Alvesta Tel: 0472-44500		Ritningsnummer SW14025179	Rev. -

Rev	Ant	Ändring och/eller medd.-nr.	Datum	Inf.	Godk.
-----	-----	-----------------------------	-------	------	-------

Handledare typ 31

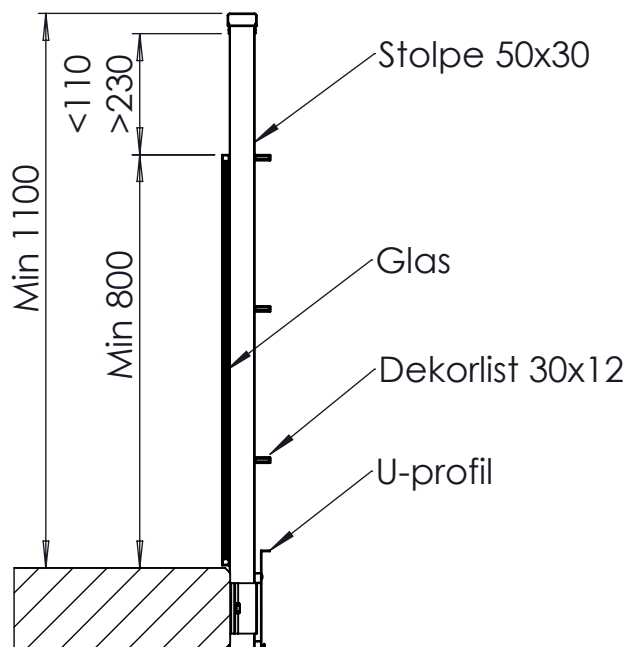
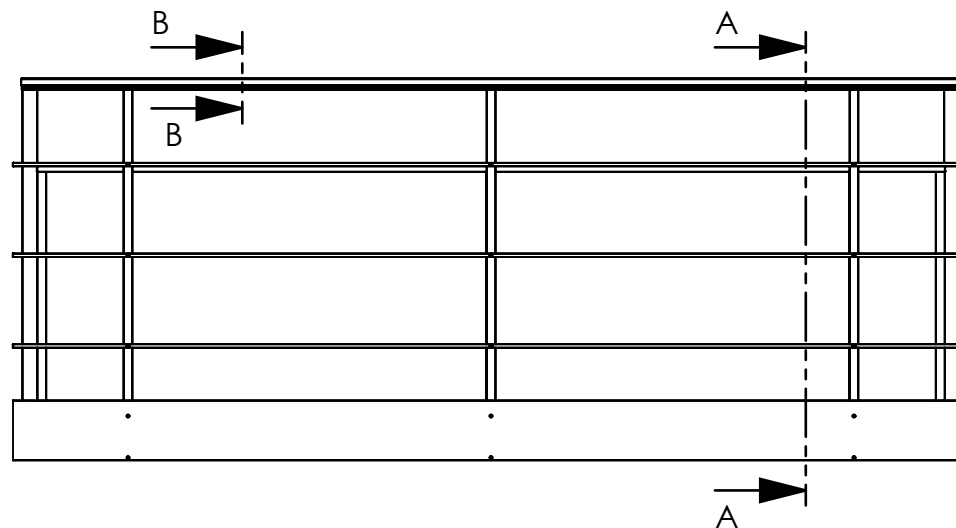
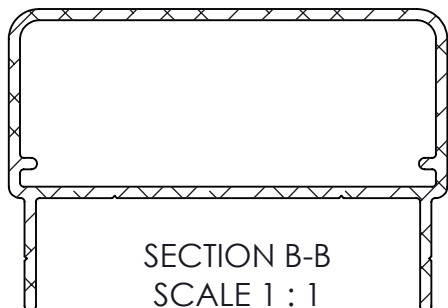

SECTION A-A
SCALE 1 : 15

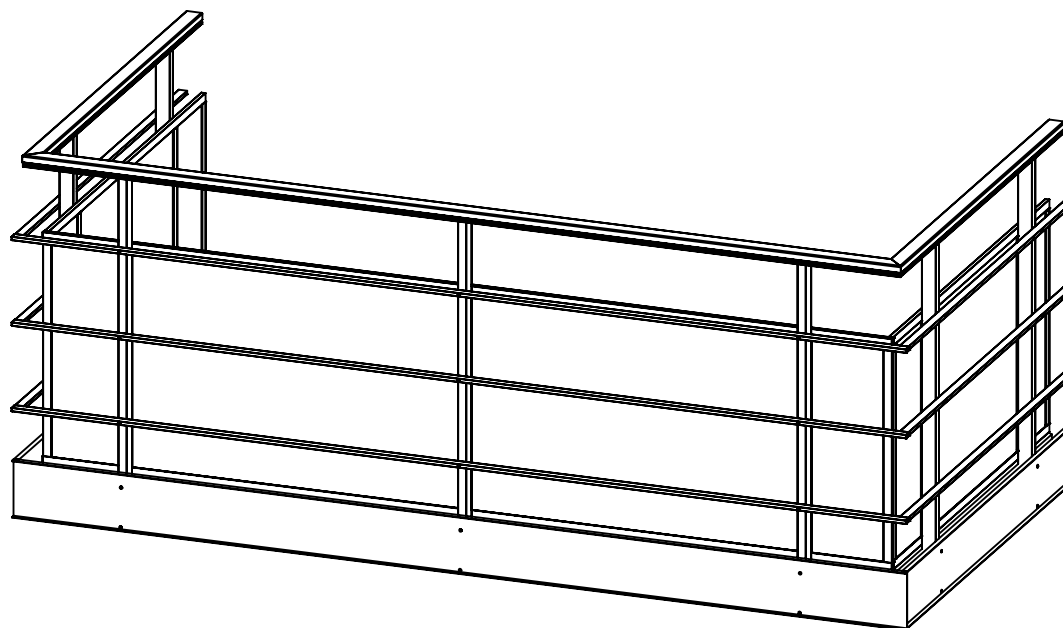

Konstr. EF	Ritad EF	Kop. -	Kontr. -	Stand. -	Godk.	Skala 1:25	Generell tolerans SS-ISO 2768-m			
							RT402 + Dekorlist 30x12 + U-profil		Ordernummer	Datum
							Björnstorpsvägen 2 342 30 Alvesta Tel: 0472-44500		Ritningsnummer SW14026210	Rev. -

Rev	Ant	Ändring och/eller medd.-nr.	Datum	Inf.	Godk.
-----	-----	-----------------------------	-------	------	-------

Handledare typ 35

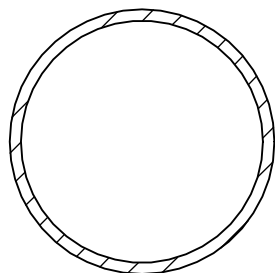

SECTION B-B
SCALE 1 : 1

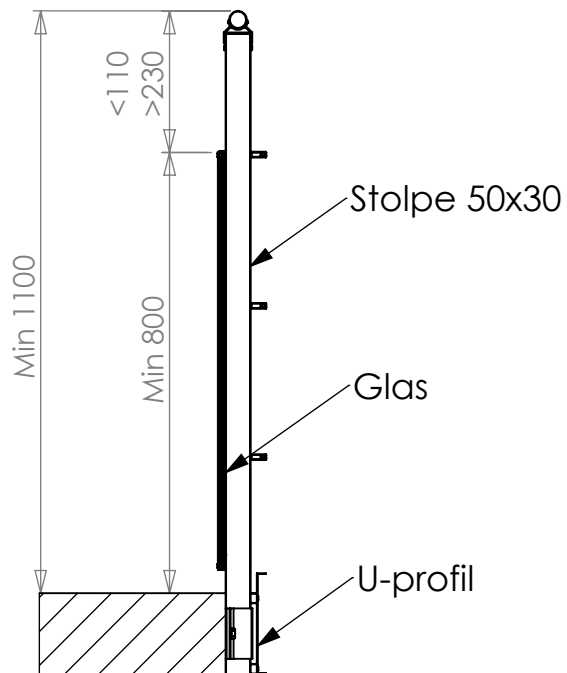
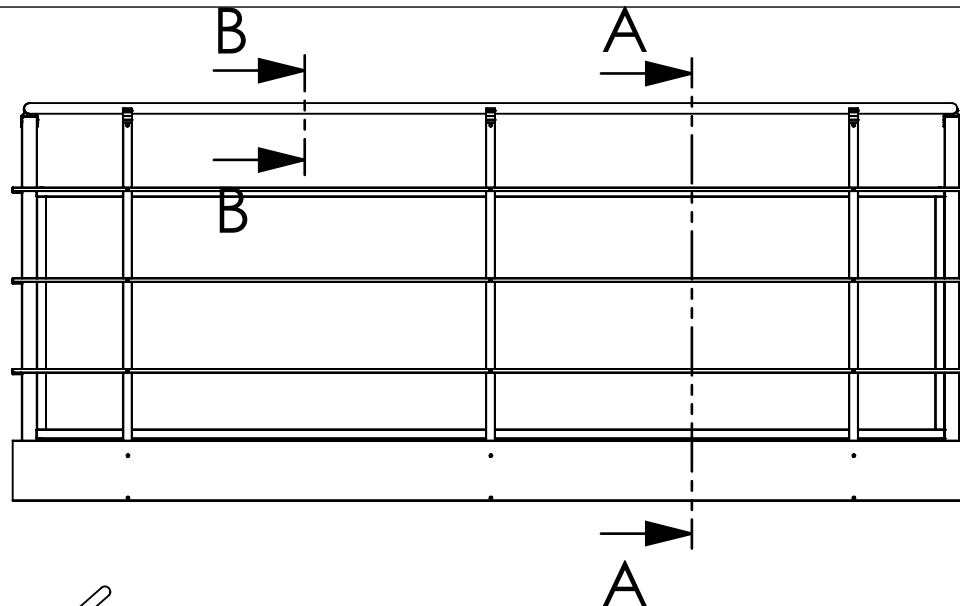

SECTION A-A
SCALE 1 : 15

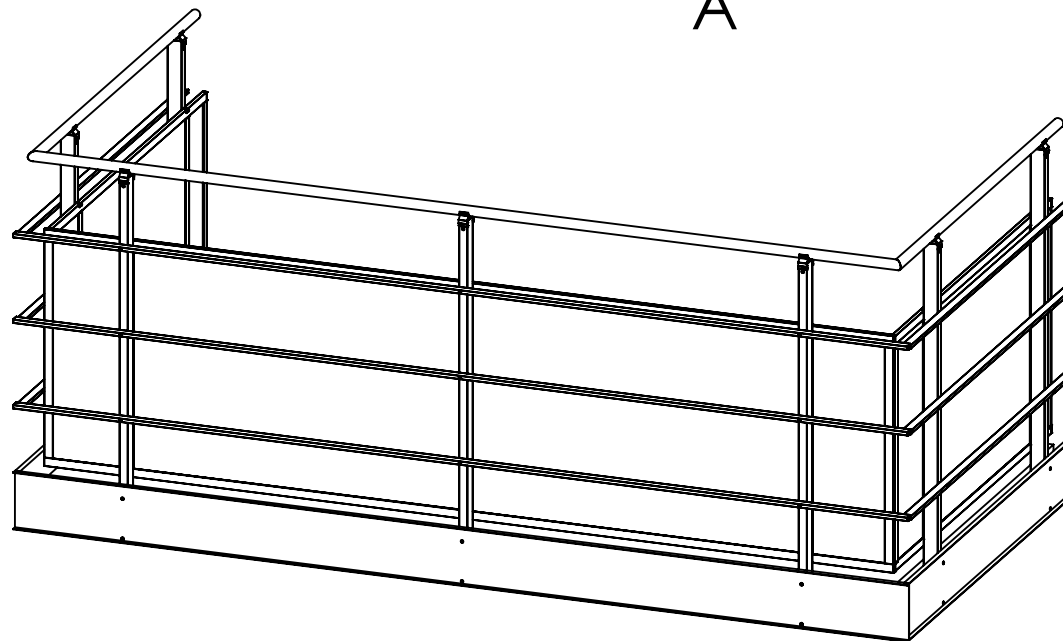

Konstr. WAP	Ritad WAP	Kop. -	Kontr. -	Stand. -	Godk.	Skala 1:25	Generell tolerans SS-ISO 2768-m			
						RT402 + Dekorlist 30x12 + U-profil			Ordernummer	Datum
						Ritningsnummer SW14018082		Rev. -		

Rev	Ant	Ändring och/eller medd.-nr.	Datum	Inf.	Godk.
-----	-----	-----------------------------	-------	------	-------

Handledare typ 50

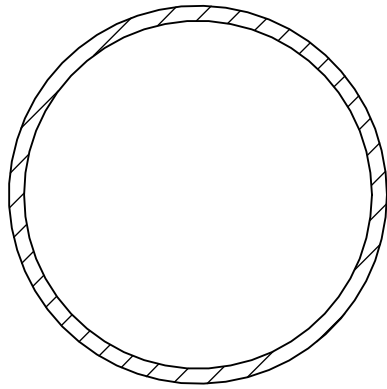

SECTION B-B
SCALE 1 : 1

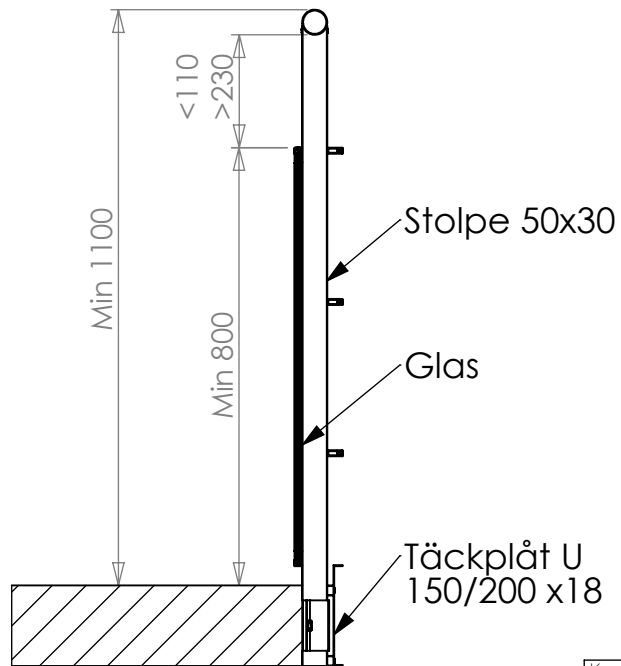
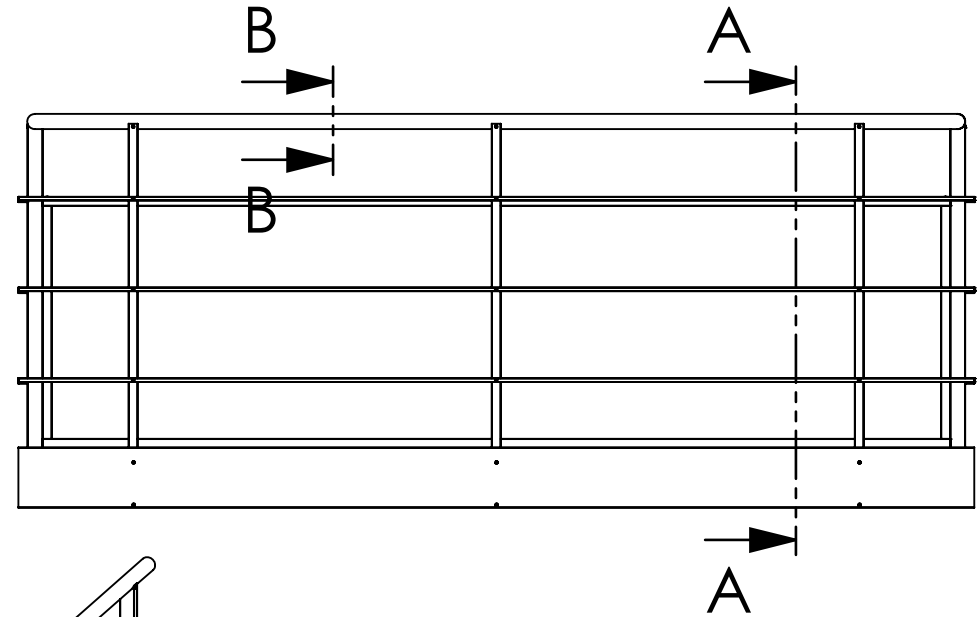

SECTION A-A
SCALE 1 : 15

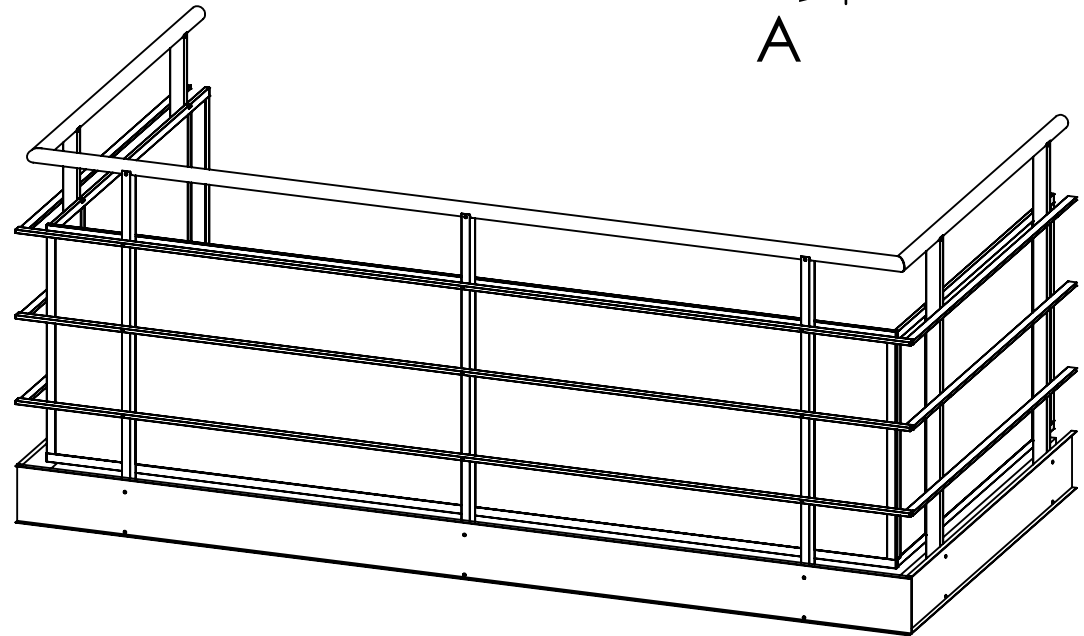

Konstr. WAP	Ritad WAP	Kop. -	Kontr. -	Stand. -	Godk.	Skala 1:25	Generell tolerans SS-ISO 2768-m	
 RT402 + Dekorlist 30x12 + U-profil							Ordernummer	Datum
							Ritningsnummer SW14018175	Rev. -

Rev	Ant	Ändring och/eller medd.-nr.	Datum	Inf.	Godk.
-----	-----	-----------------------------	-------	------	-------

Björnstorpsvägen 2
342 30 Alvesta
Tel: 0472-44500

Handledare typ 55x15

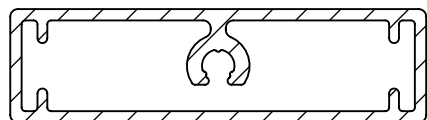

SECTION B-B
SCALE 1 : 1

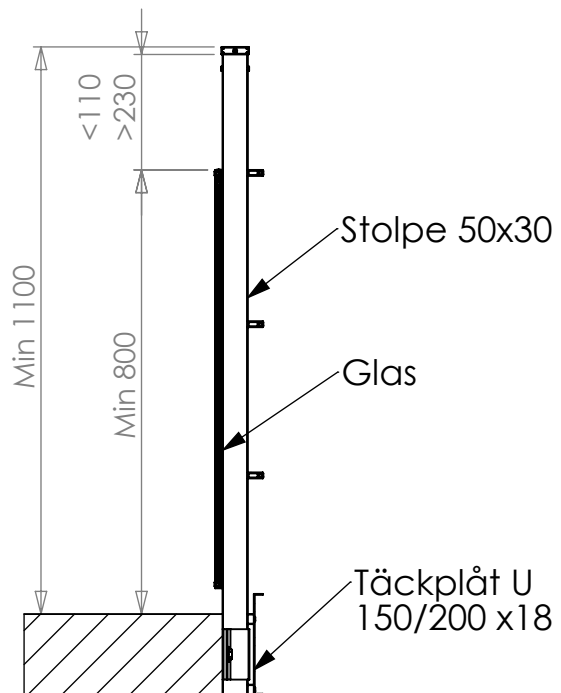

SECTION A-A
SCALE 1 : 15

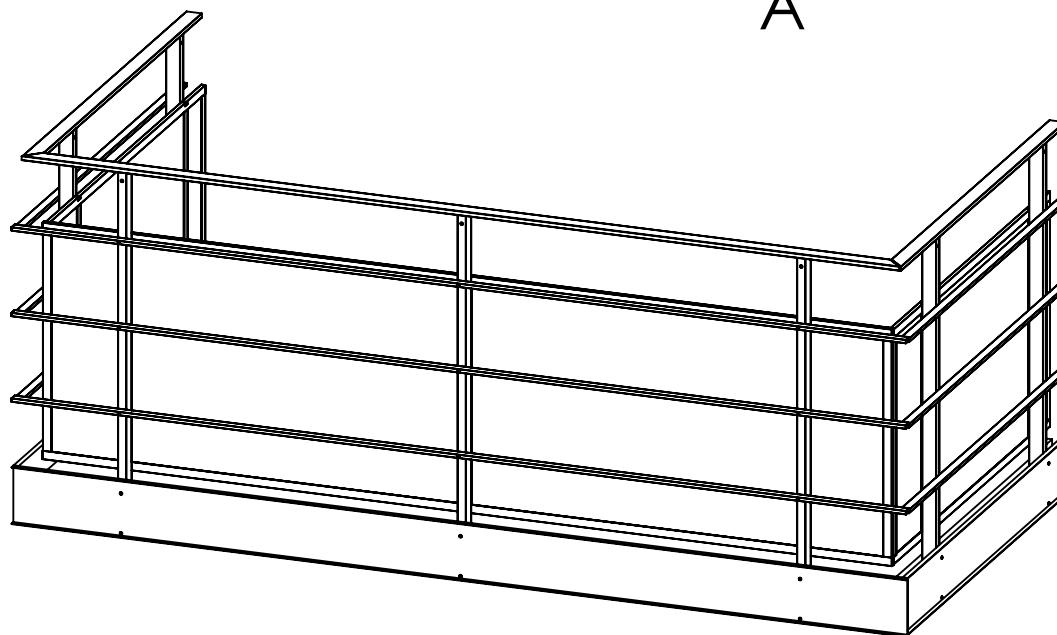
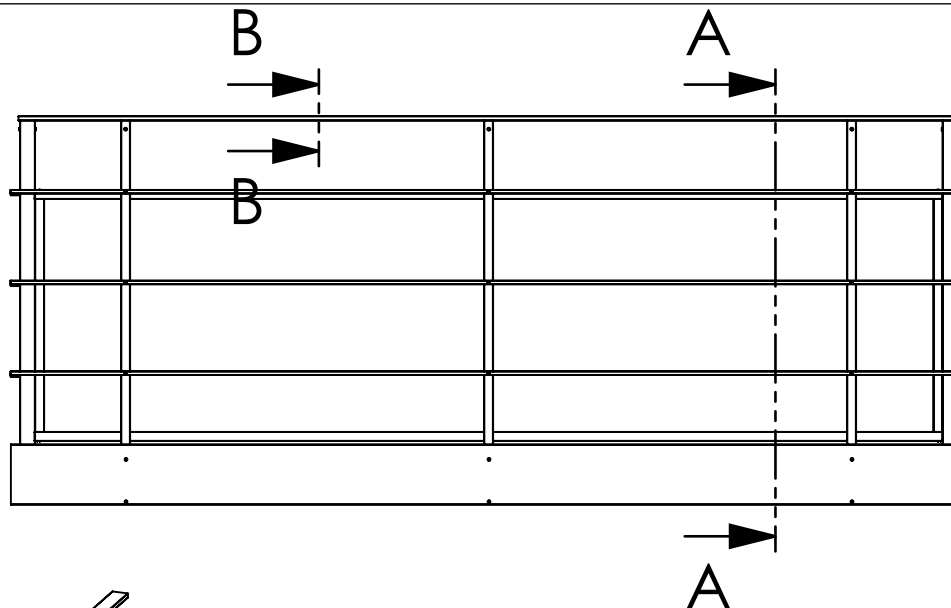

Konstr. WAP	Ritad WAP	Kop. -	Kontr. -	Stand. -	Godk.	Skala 1:25	Generell tolerans SS-ISO 2768-m			
							RT400 Glas på insida+3st dekorer 30×12+Täckplåt U		Ordernummer	Datum 2021-03-22
							Ritningsnummer SW14018267		Rev. -	

Rev	Ant	Ändring och/eller medd.-nr.	Datum	Inf.	Godk.
-----	-----	-----------------------------	-------	------	-------

Björnstorpsvägen 2
342 30 Alvesta
Tel: 0472-44500

Handledare typ U

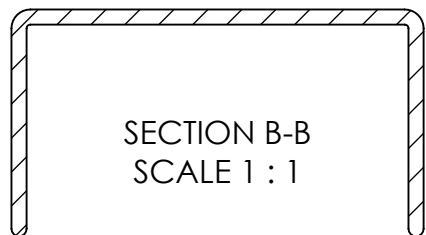

SECTION B-B
SCALE 1 : 1

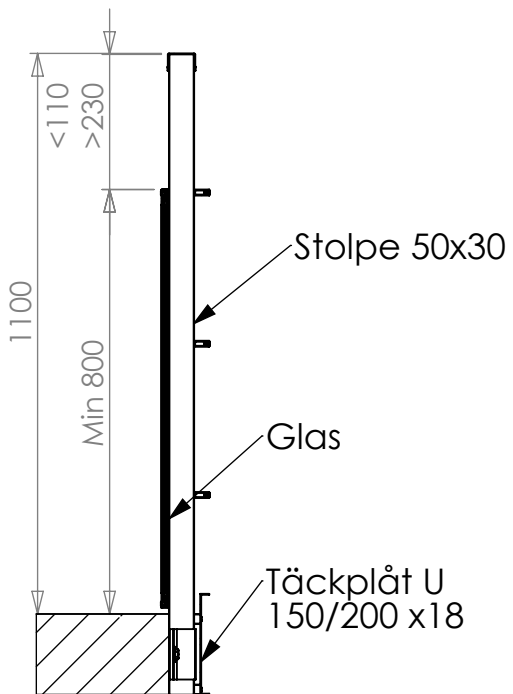

SECTION A-A
SCALE 1 : 15

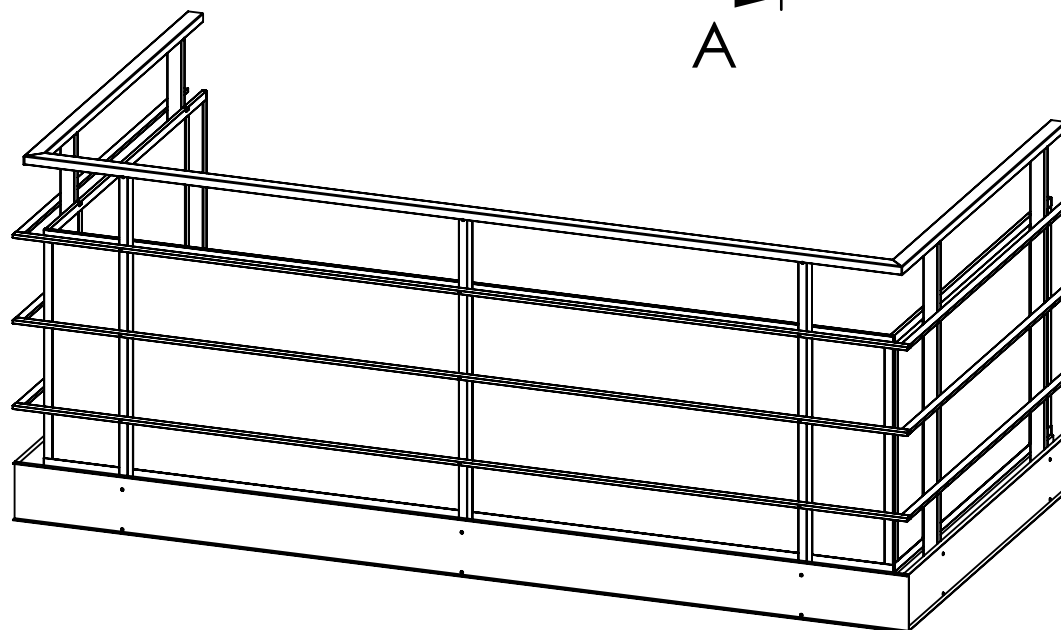
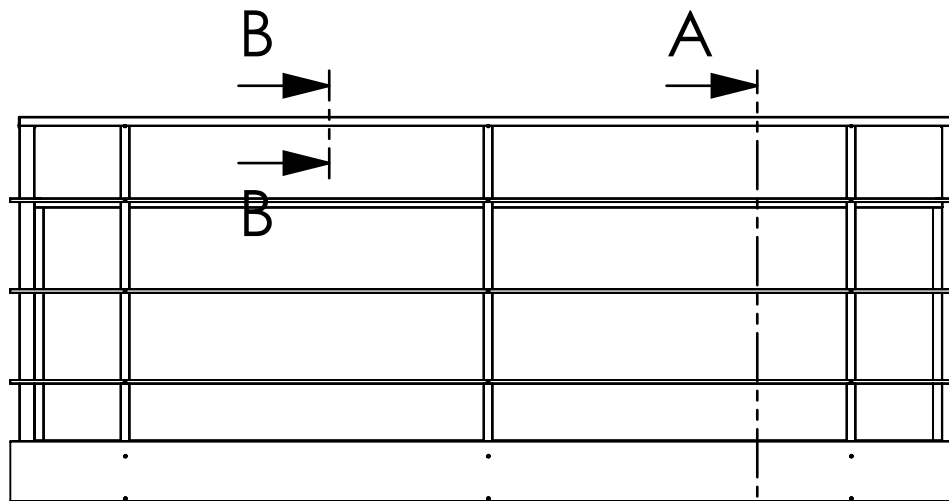

Konstr. WAP	Ritad WAP	Kop. -	Kontr. -	Stand. -	Godk.	Skala 1:25	Generell tolerans SS-ISO 2768-m	
							RT400 Glas på insida+3st dekorer 30×12+Täckplåt U	
							Ordernummer	Datum
							Ritningsnummer	Rev.
							SW14018439	-

Rev	Ant	Ändring och/eller medd.-nr.	Datum	Inf.	Godk.
-----	-----	-----------------------------	-------	------	-------

WELAND ALUMINIUM AB

This document must not be copied without our written permission and the contents thereof must not be imparted to a third party nor be used for any unauthorized purpose. Contravention will be prosecuted.



Konstr. EF	Ritad EF	Kop. -	Kontr. -	Stand. -	Godk.	Skala 1:25	Generell tolerans SS-ISO 2768-m	
			RT402 + Dekorlist 30x12 + U-profil			Ordernummer	Datum	
						Ritningsnummer SW14025179		Rev. -

Rev	Ant	Ändring och/eller medd.-nr.	Datum	Inf.	Godk.
-----	-----	-----------------------------	-------	------	-------

Björnstorpsvägen 2
342 30 Alvesta
Tel: 0472-44500