

Handledare typ 21

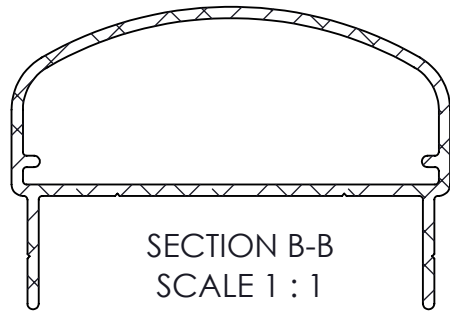

SECTION B-B
SCALE 1 : 1

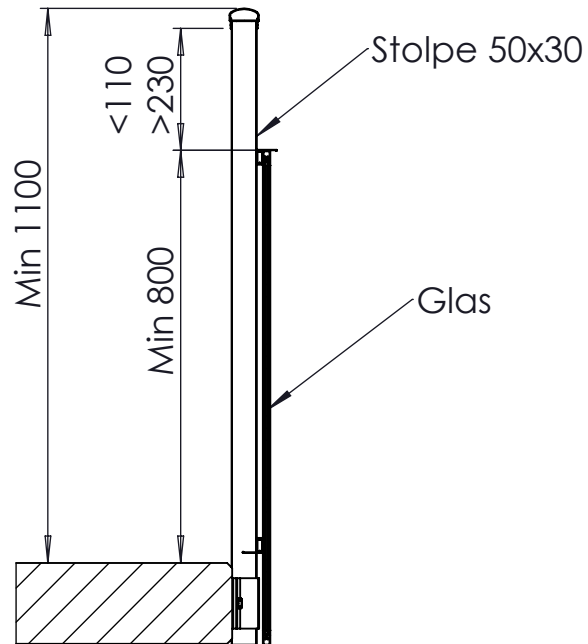
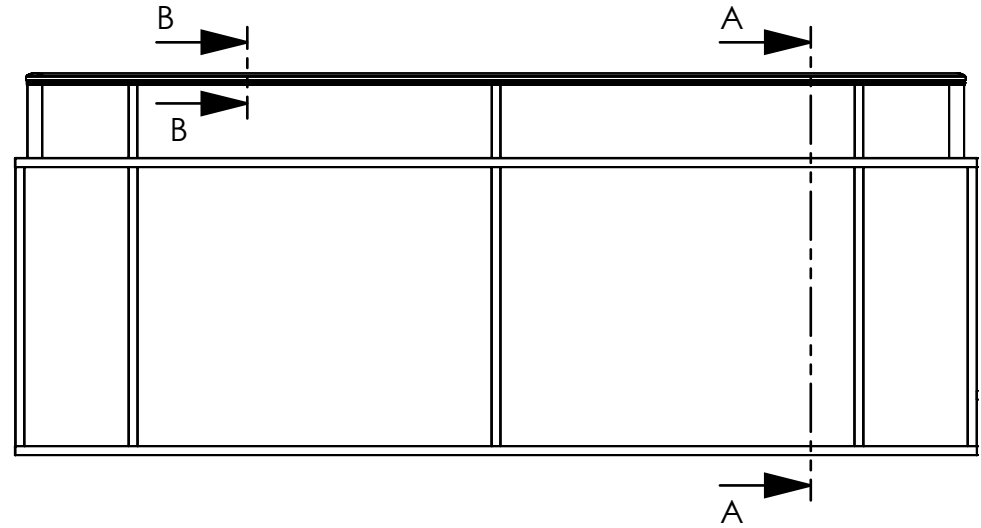

SECTION A-A
SCALE 1 : 15

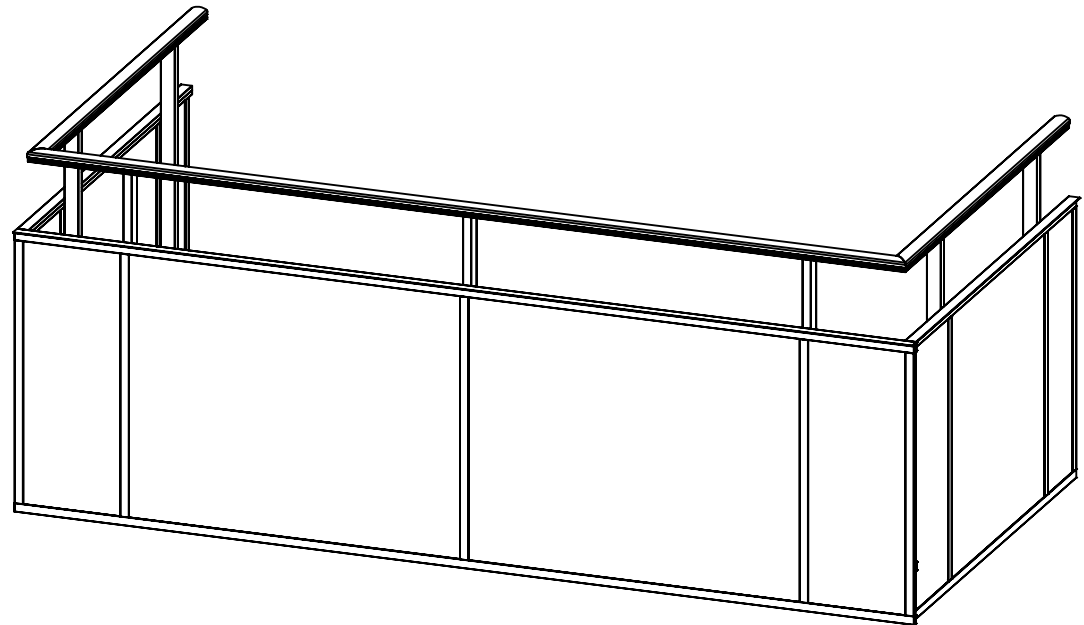

Konstr. EF	Ritad EF	Kop. -	Kontr. -	Stand. -	Godk.	Skala 1:25	Generell tolerans SS-ISO 2768-m		
						RT401 Täckt plattkant		Ordernummer	Datum
						Ritningsnummer SW14025202		Rev. -	

Rev	Ant	Ändring och/eller medd.-nr.	Datum	Inf.	Godk.
-----	-----	-----------------------------	-------	------	-------

Björnstorpsvägen 2
342 30 Alvesta
Tel: 0472-44500

Handledare typ 21

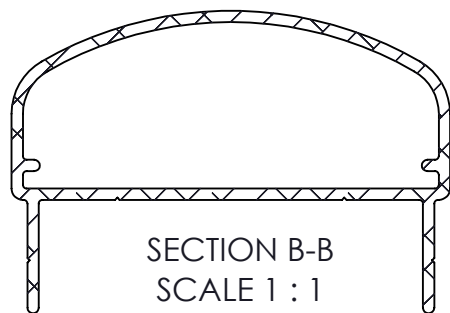

SECTION B-B
SCALE 1 : 1

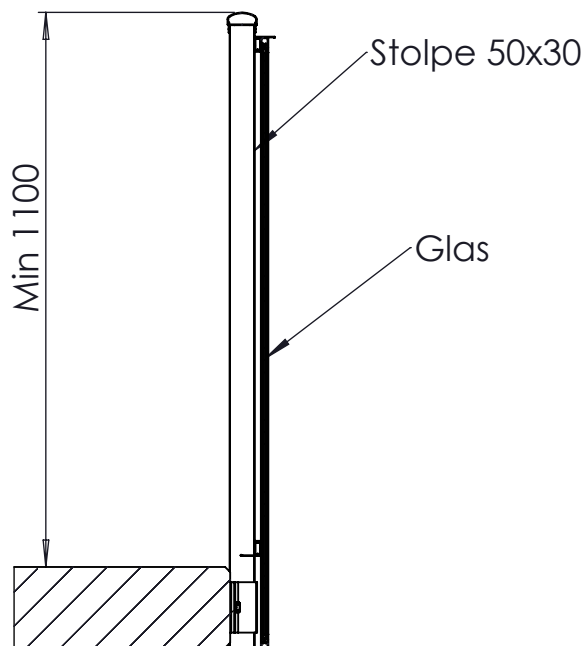
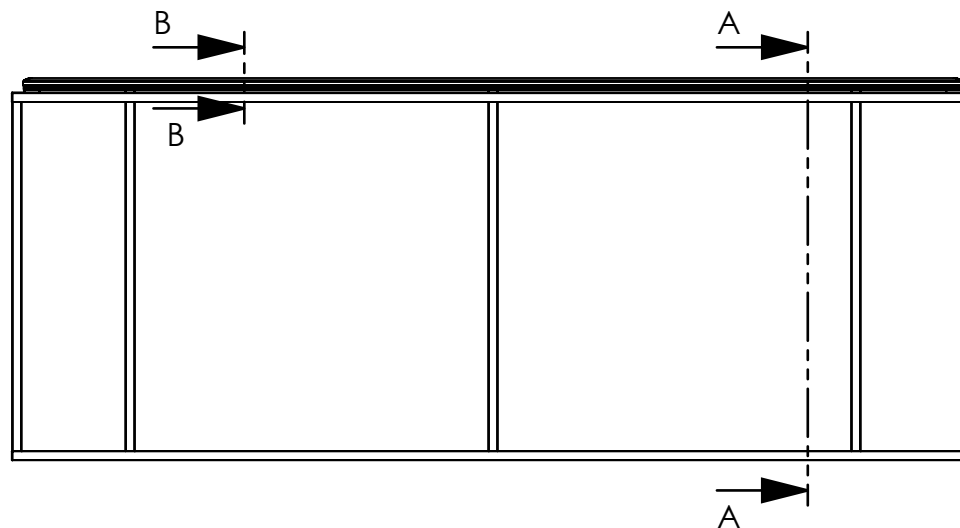

SECTION A-A
SCALE 1 : 15

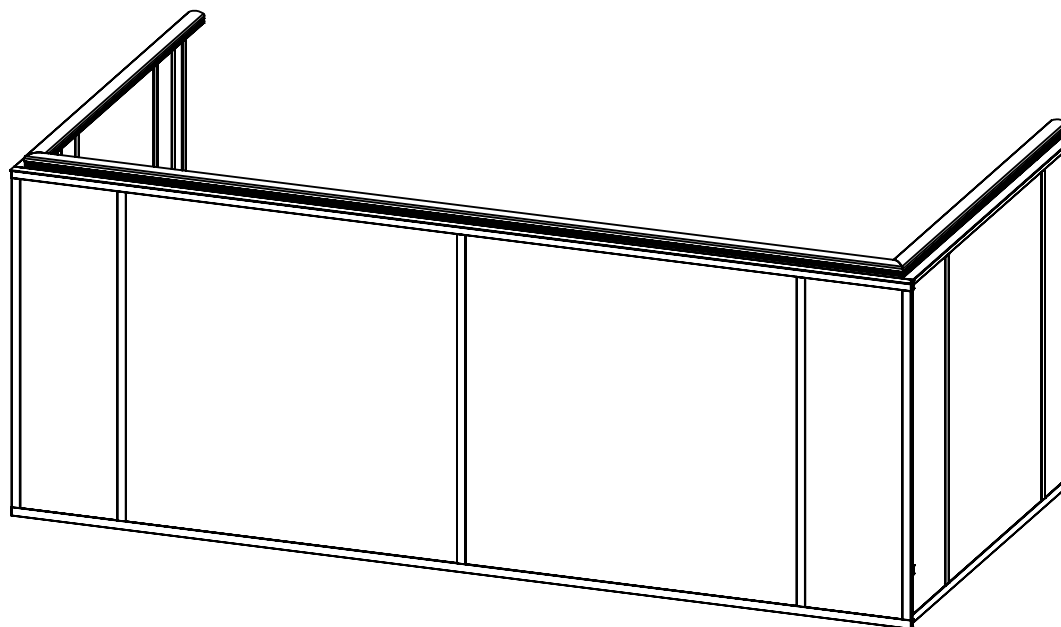

Konstr. EF	Ritad EF	Kop. -	Kontr. -	Stand. -	Godk.	Skala 1:25	Generell tolerans SS-ISO 2768-m		
						RT401H Täckt plattkant		Ordernummer	Datum
						Ritningsnummer SW14025290		Rev. -	

Rev	Ant	Ändring och/eller medd.-nr.	Datum	Inf.	Godk.
-----	-----	-----------------------------	-------	------	-------

Björnstorpsvägen 2
342 30 Alvesta
Tel: 0472-44500

Handledare typ 31

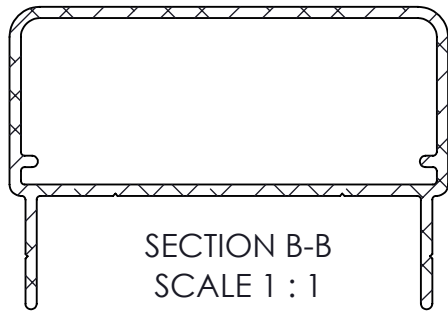

SECTION B-B
SCALE 1 : 1

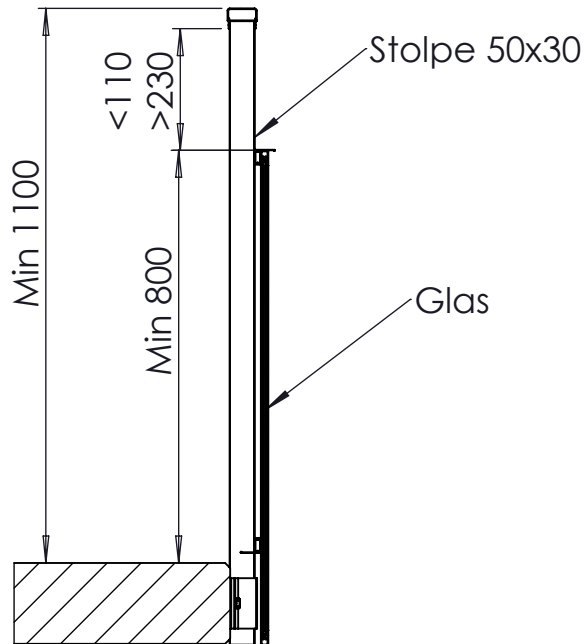
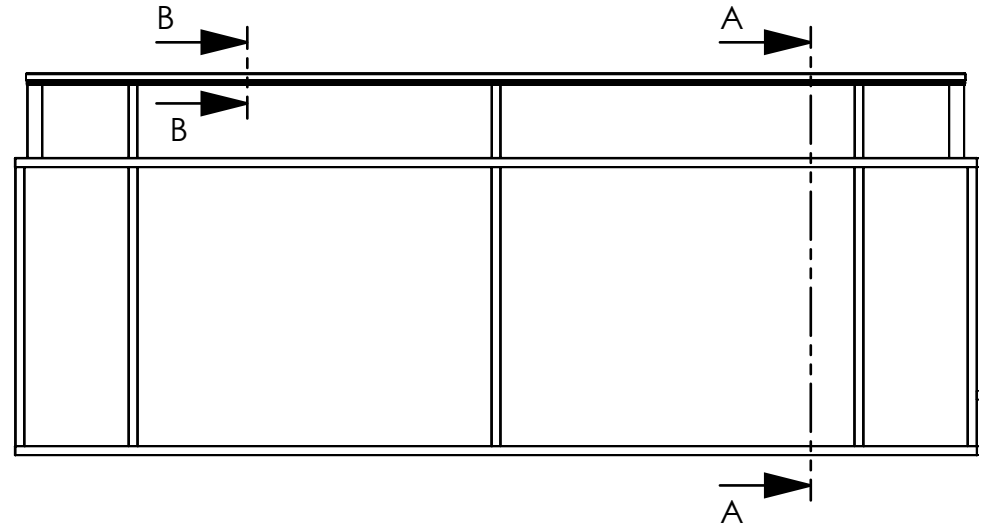

SECTION A-A
SCALE 1 : 15

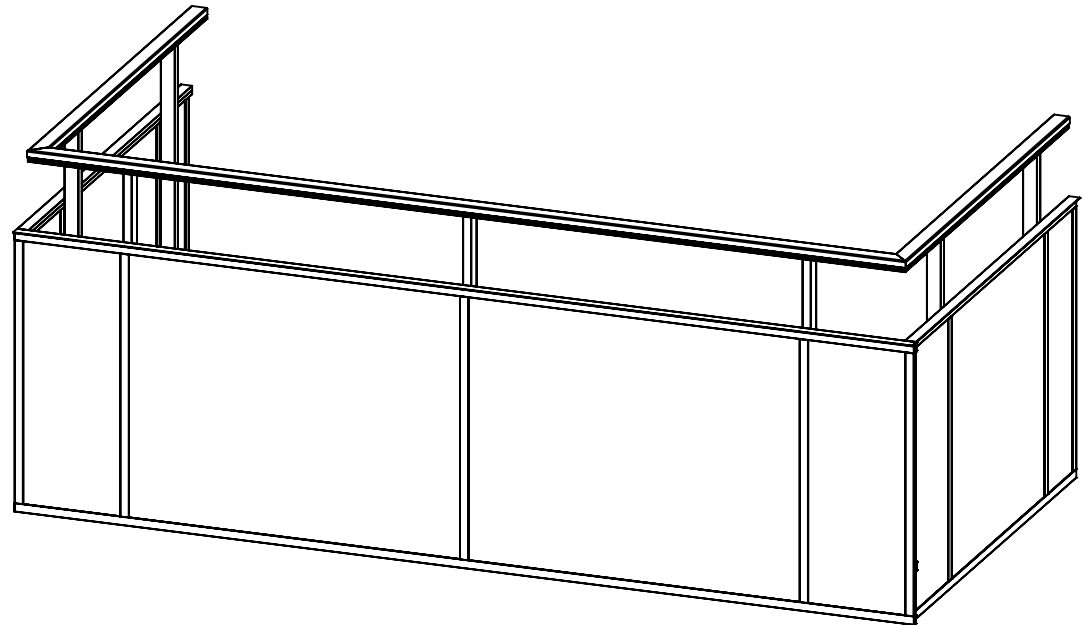

Konstr. EF	Ritad EF	Kop. -	Kontr. -	Stand. -	Godk.	Skala 1:25	Generell tolerans SS-ISO 2768-m			
							RT401 Täckt plattkant		Ordernummer	Datum
							Ritningsnummer SW14026173		Rev. -	

Rev	Ant	Ändring och/eller medd.-nr.	Datum	Inf.	Godk.
-----	-----	-----------------------------	-------	------	-------

Handledare typ 31

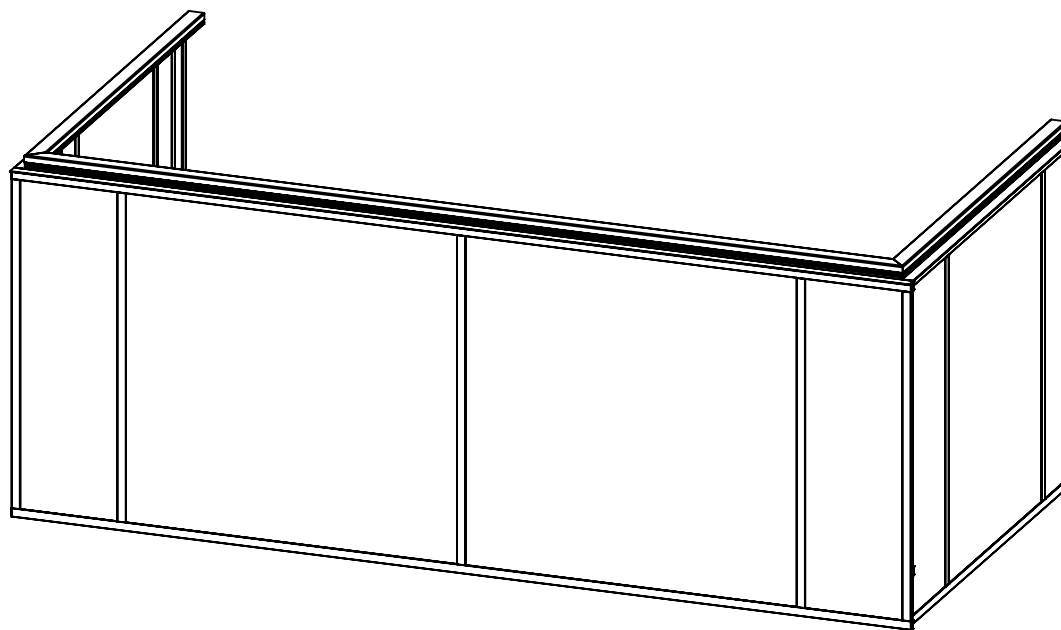
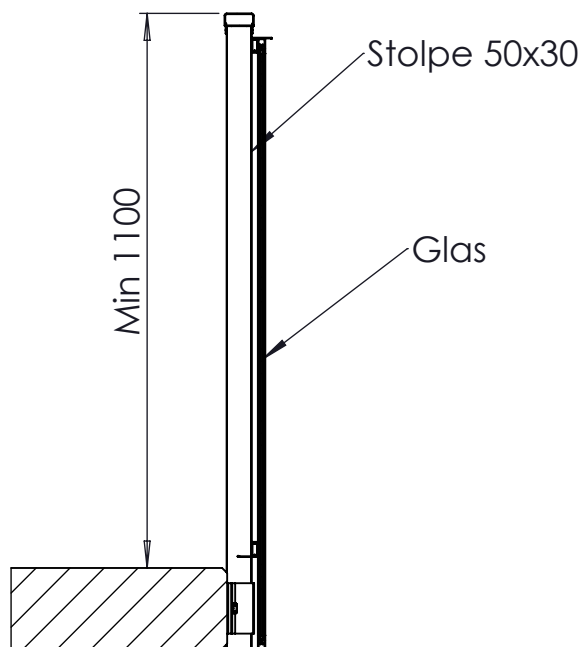
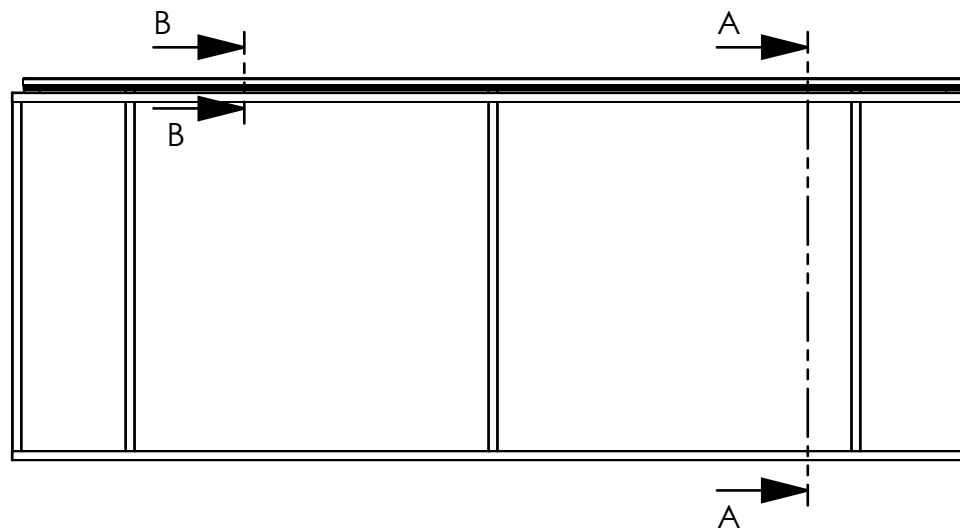
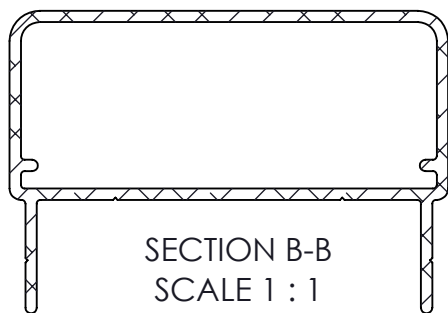

SECTION A-A
SCALE 1 : 15

Konstr. EF	Ritad EF	Kop. -	Kontr. -	Stand. -	Godk.	Skala 1:25	Generell tolerans SS-ISO 2768-m		
						RT401H Täckt plattkant		Ordernummer	Datum
						Ritningsnummer SW14026287		Rev. -	

Rev	Ant	Ändring och/eller medd.-nr.	Datum	Inf.	Godk.
-----	-----	-----------------------------	-------	------	-------

Björnstorpsvägen 2
342 30 Alvesta
Tel: 0472-44500

Handledare typ 35

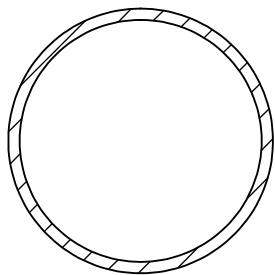

SECTION B-B
SCALE 1 : 1

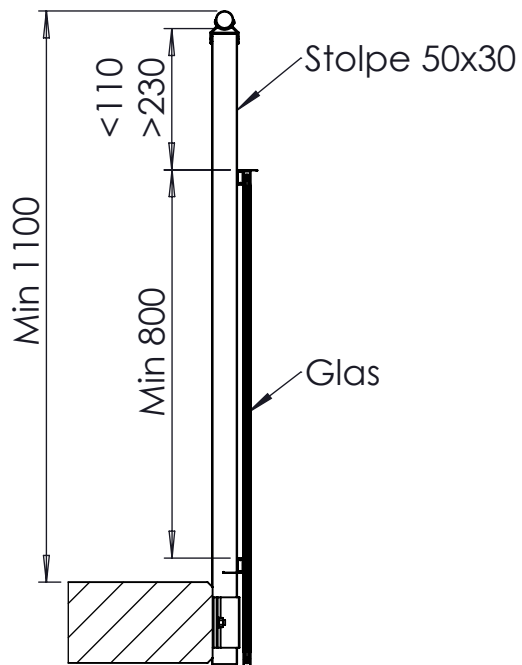

SECTION A-A
SCALE 1 : 15

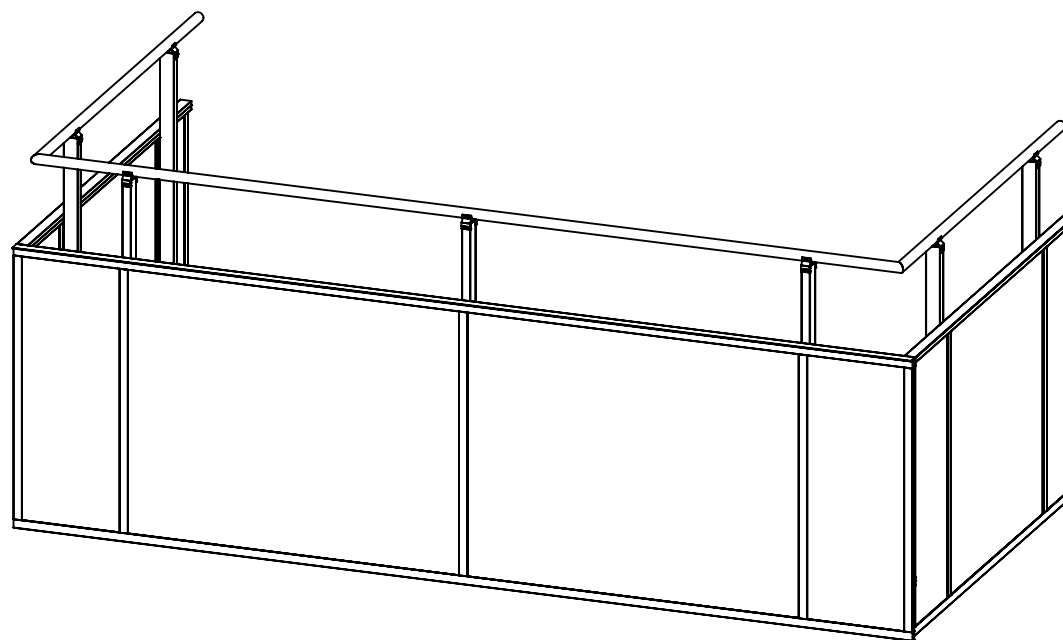
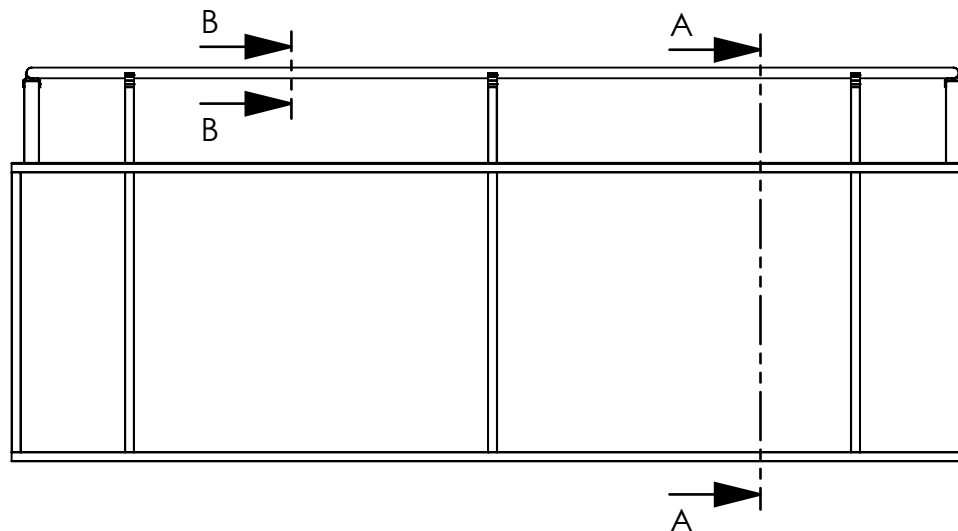

Konstr. AK	Ritad AK	Kop. -	Kontr. -	Stand. -	Godk.	Skala 1:25	Generell tolerans SS-ISO 2768-m			
							RT401 Täckt plattkant		Ordernummer PRINCIP	Datum
							Ritningsnummer 14006706		Rev.	

Rev	Ant	Ändring och/eller medd.-nr.	Datum	Inf.	Godk.
-----	-----	-----------------------------	-------	------	-------

Handledare typ 35

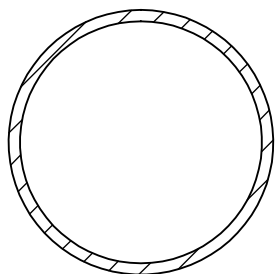

SECTION B-B
SCALE 1 : 1

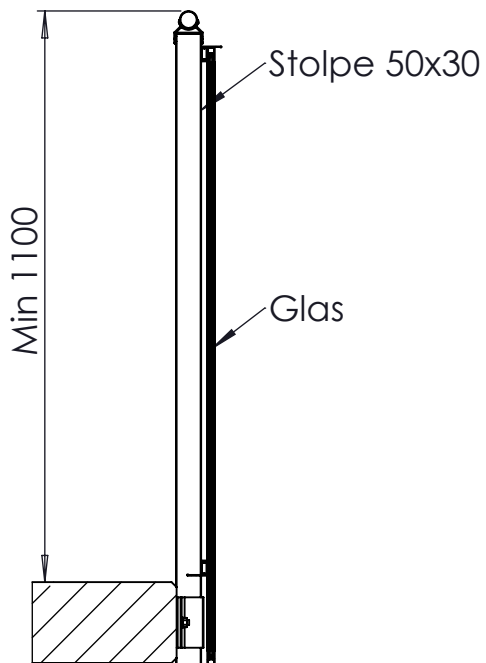

SECTION A-A
SCALE 1 : 15

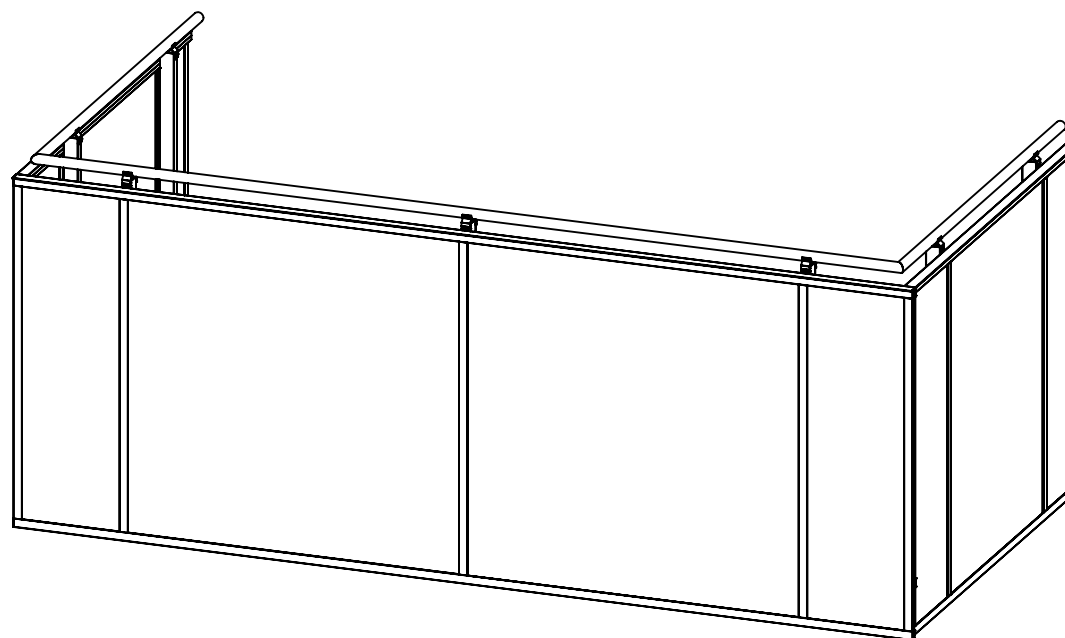
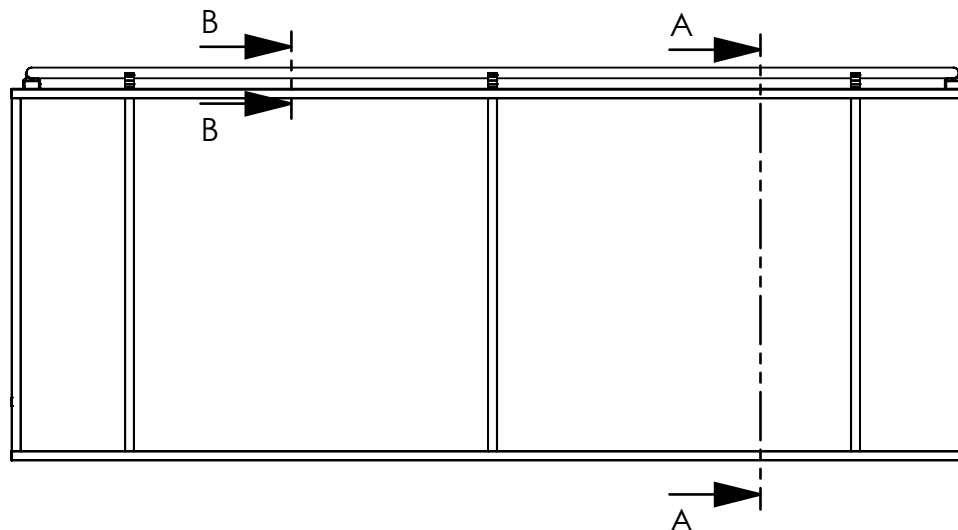

Konstr. AK	Ritad AK	Kop. -	Kontr. -	Stand. -	Godk.	Skala 1:25	Generell tolerans SS-ISO 2768-m			
							RT401H Täckt plattkant		Ordernummer PRINCIP	Datum
							Ritningsnummer 14008387		Rev.	

Rev	Ant	Ändring och/eller medd.-nr.	Datum	Inf.	Godk.
-----	-----	-----------------------------	-------	------	-------

Björnstorpsvägen 2
342 30 Alvesta
Tel: 0472-44500

Handledare typ 50

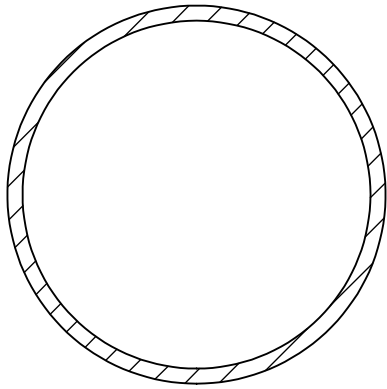

SECTION B-B
SCALE 1 : 1

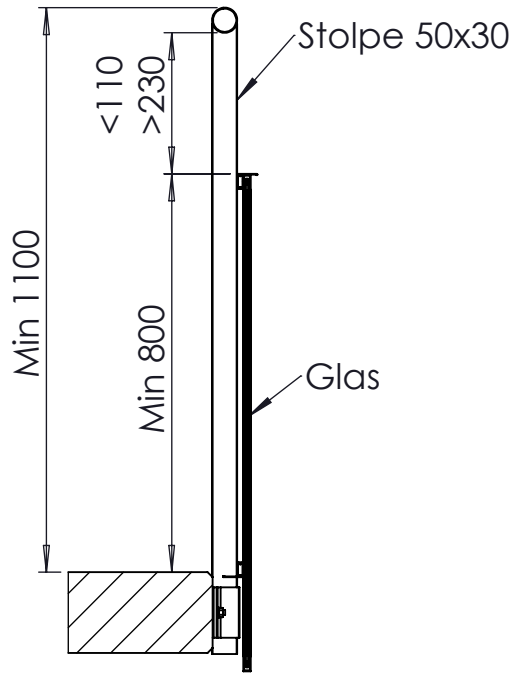
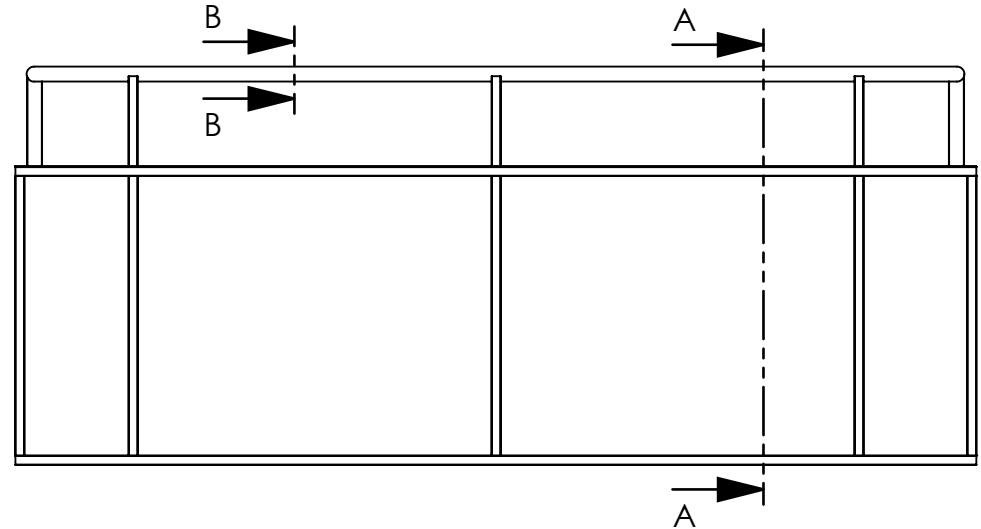

SECTION A-A
SCALE 1 : 15

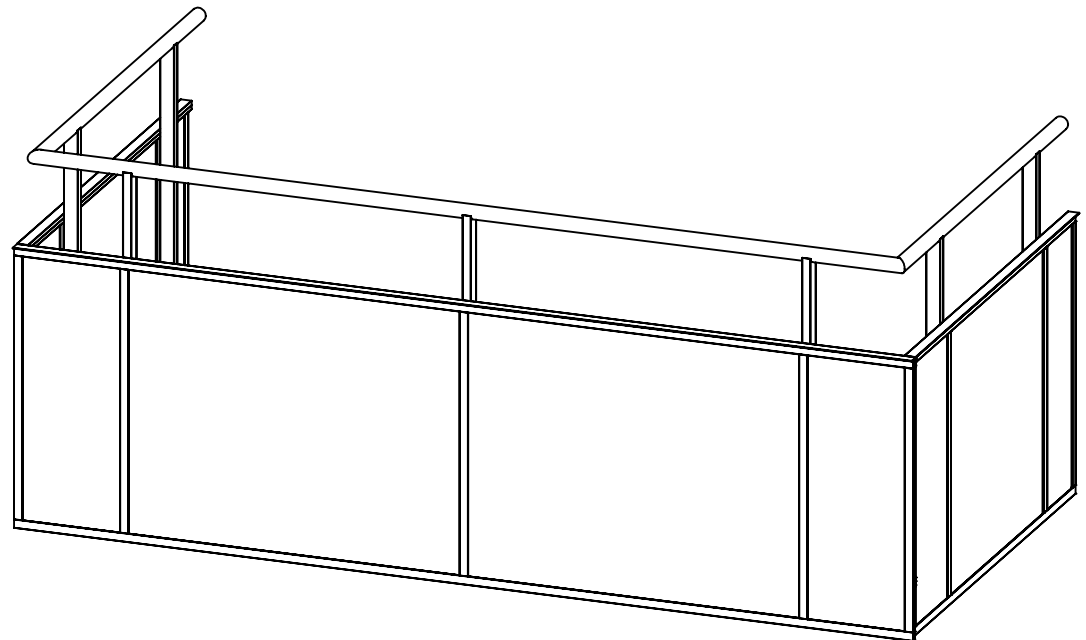

Konstr. AK	Ritad AK	Kop. -	Kontr. -	Stand. -	Godk.	Skala 1:25	Generell tolerans SS-ISO 2768-m			
							RT401 Täckt plattkant		Ordernummer PRINCIP	Datum
							Ritningsnummer 14006928		Rev.	

Rev	Ant	Ändring och/eller medd.-nr.	Datum	Inf.	Godk.
-----	-----	-----------------------------	-------	------	-------

Handledare typ 50

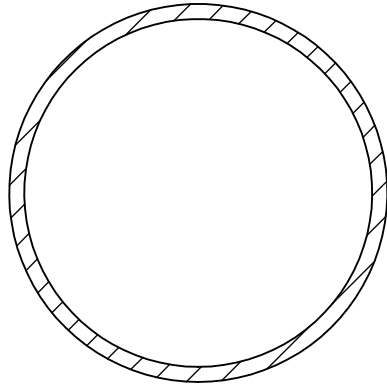

SECTION B-B
SCALE 1 : 1

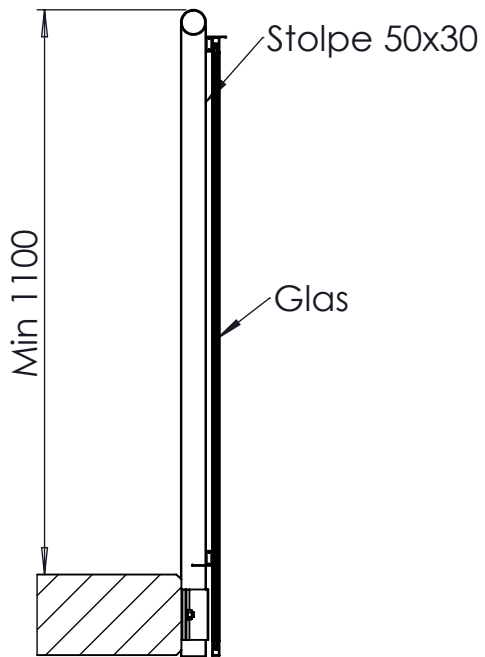
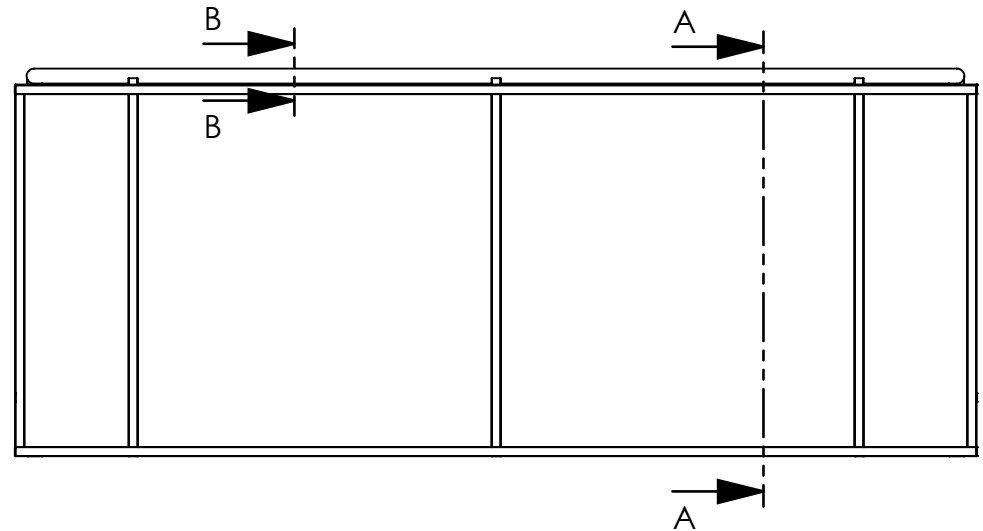

SECTION A-A
SCALE 1 : 15

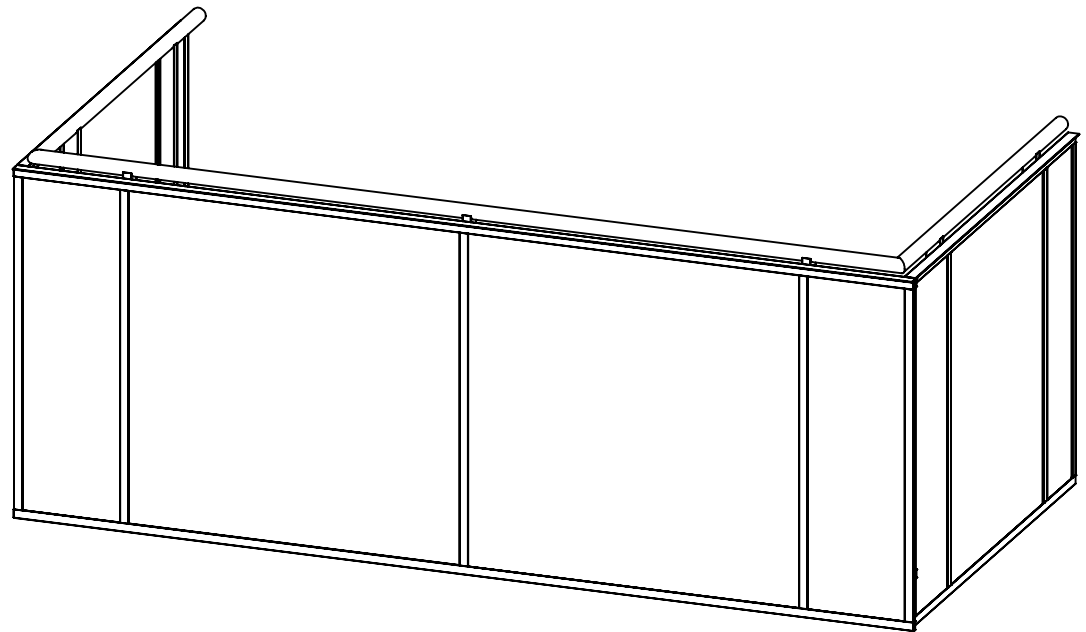

Konstr. AK	Ritad AK	Kop. -	Kontr. -	Stand. -	Godk.	Skala 1:25	Generell tolerans SS-ISO 2768-m			
							RT401H Täckt plattkant		Ordernummer PRINCIP	Datum
							Ritningsnummer 14008434		Rev.	

Rev	Ant	Ändring och/eller medd.-nr.	Datum	Inf.	Godk.
-----	-----	-----------------------------	-------	------	-------

Handledare typ 55x15

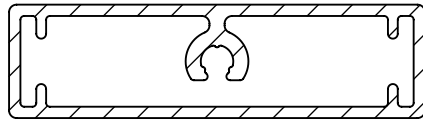

SECTION B-B
SCALE 1 : 1

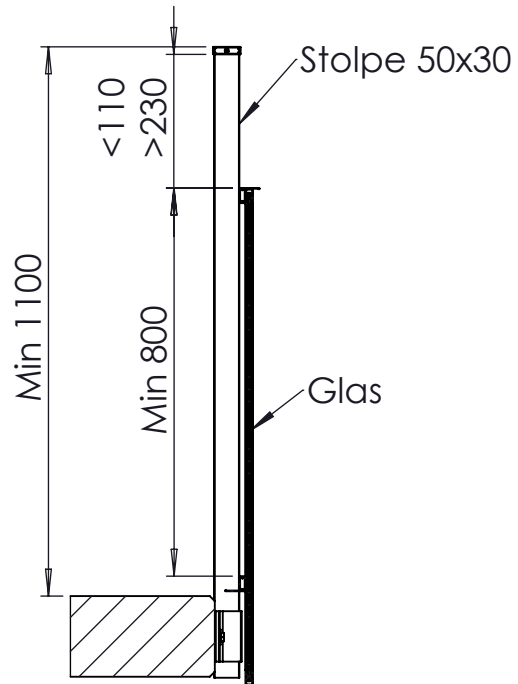

SECTION A-A
SCALE 1 : 15

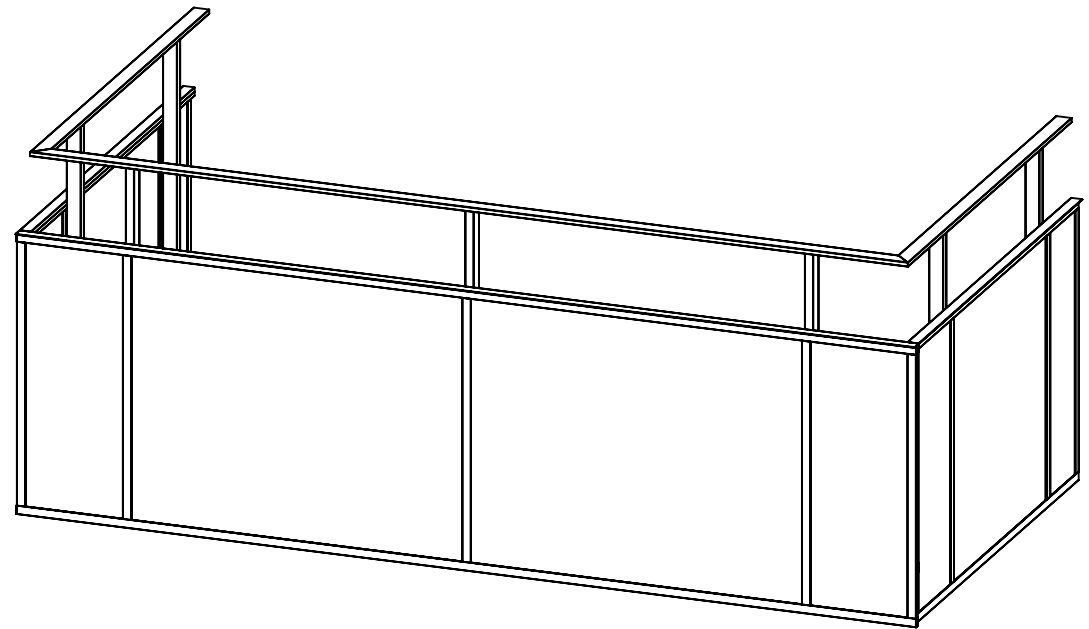
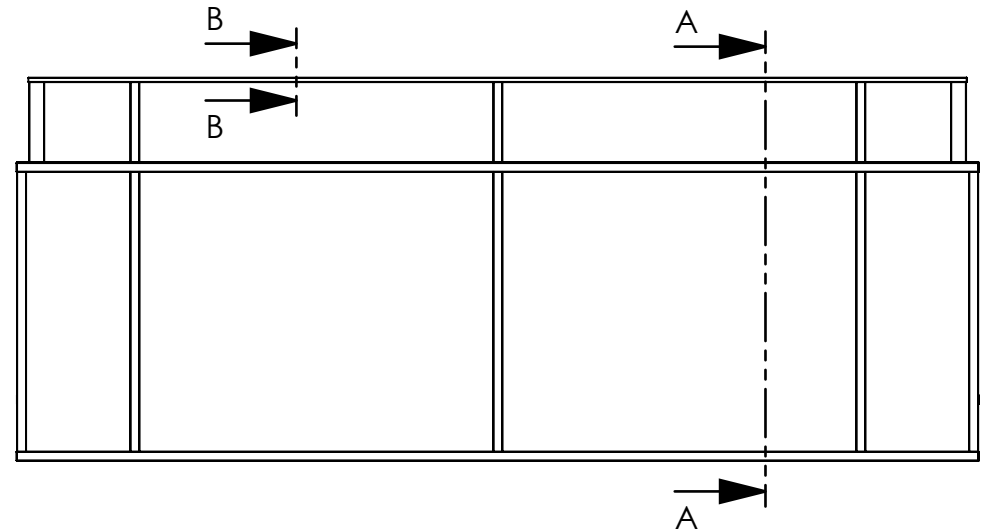

Konstr. AK	Ritad AK	Kop. -	Kontr. -	Stand. -	Godk.	Skala 1:25	Generell tolerans SS-ISO 2768-m			
							RT400 Täckt plattkant		Ordernummer PRINCIP	Datum 2020-11-03
							Ritningsnummer 14007158		Rev.	

Rev	Ant	Ändring och/eller medd.-nr.	Datum	Inf.	Godk.
-----	-----	-----------------------------	-------	------	-------

Handledare typ 55x15

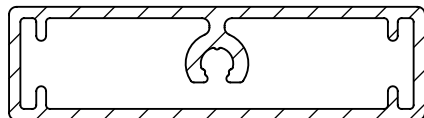

SECTION B-B
SCALE 1 : 1

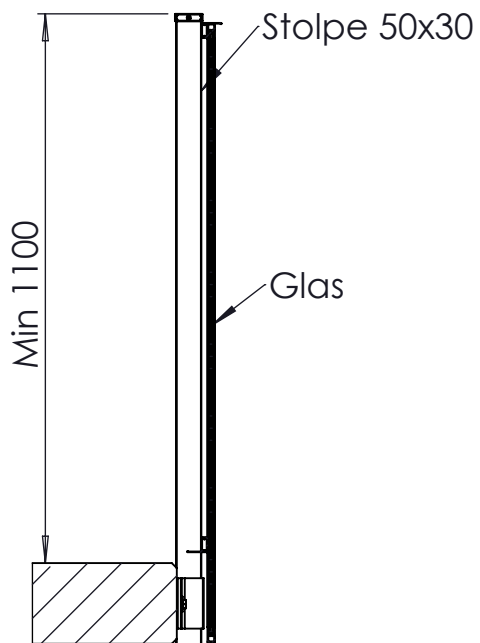
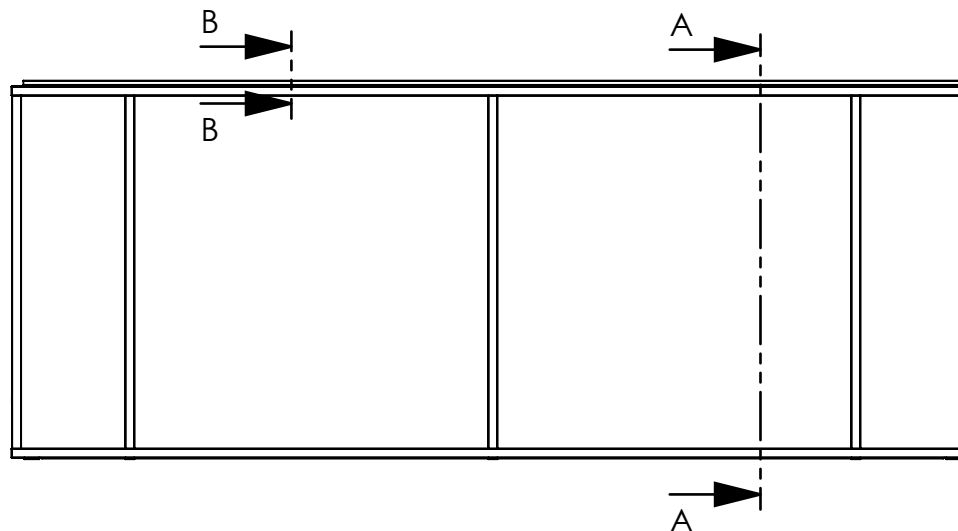

SECTION A-A
SCALE 1 : 15

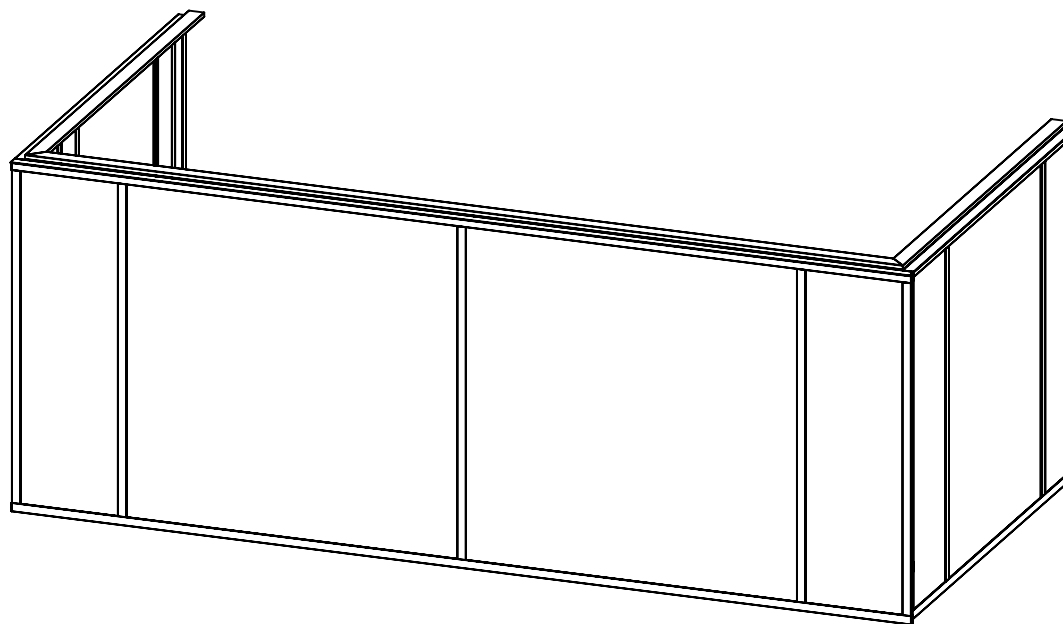

Konstr. AK	Ritad AK	Kop. -	Kontr. -	Stand. -	Godk.	Skala 1:25	Generell tolerans SS-ISO 2768-m	
 RT400H Täckt plattkant							Ordernummer PRINCIP	Datum 2020-11-04
							Ritningsnummer 14008481	Rev.

Rev	Ant	Ändring och/eller medd.-nr.	Datum	Inf.	Godk.
-----	-----	-----------------------------	-------	------	-------

Handledare typ U

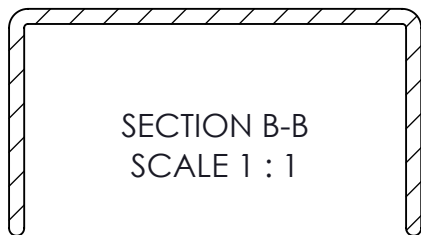

SECTION B-B
SCALE 1 : 1

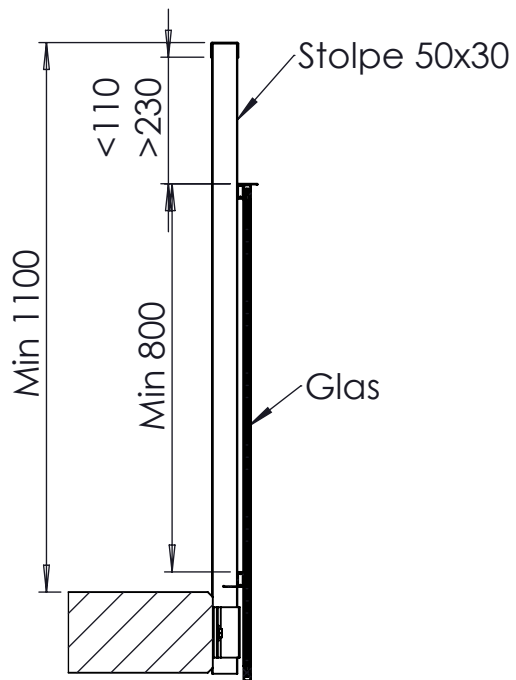

SECTION A-A
SCALE 1 : 15

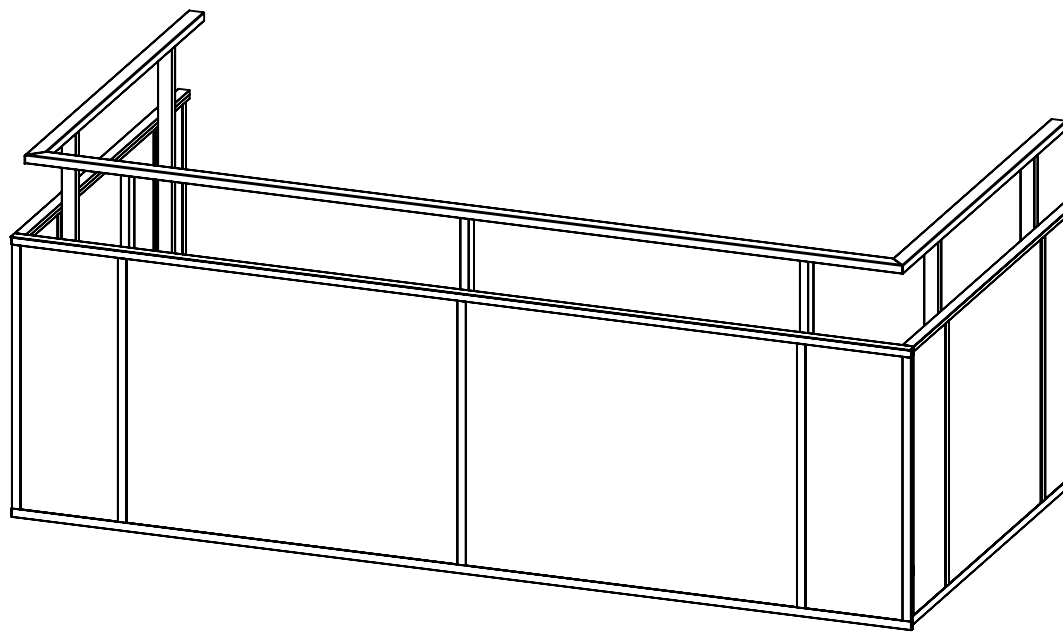
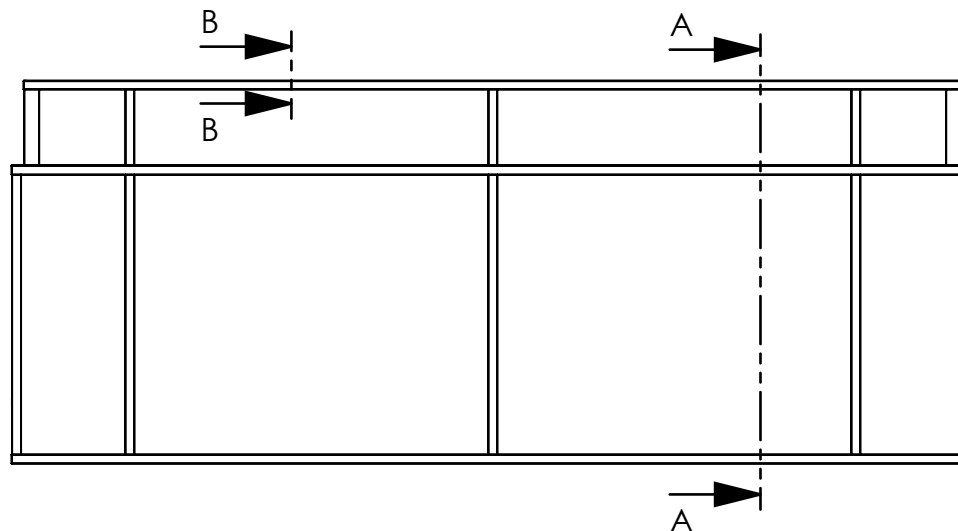

Konstr. AK	Ritad AK	Kop. -	Kontr. -	Stand. -	Godk.	Skala 1:25	Generell tolerans SS-ISO 2768-m	
 RT400 Täckt plattkant							Ordernummer PRINCIP	Datum 2020-11-04
							Ritningsnummer 14007410	Rev.

Rev	Ant	Ändring och/eller medd.-nr.	Datum	Inf.	Godk.
-----	-----	-----------------------------	-------	------	-------

Handledare typ U

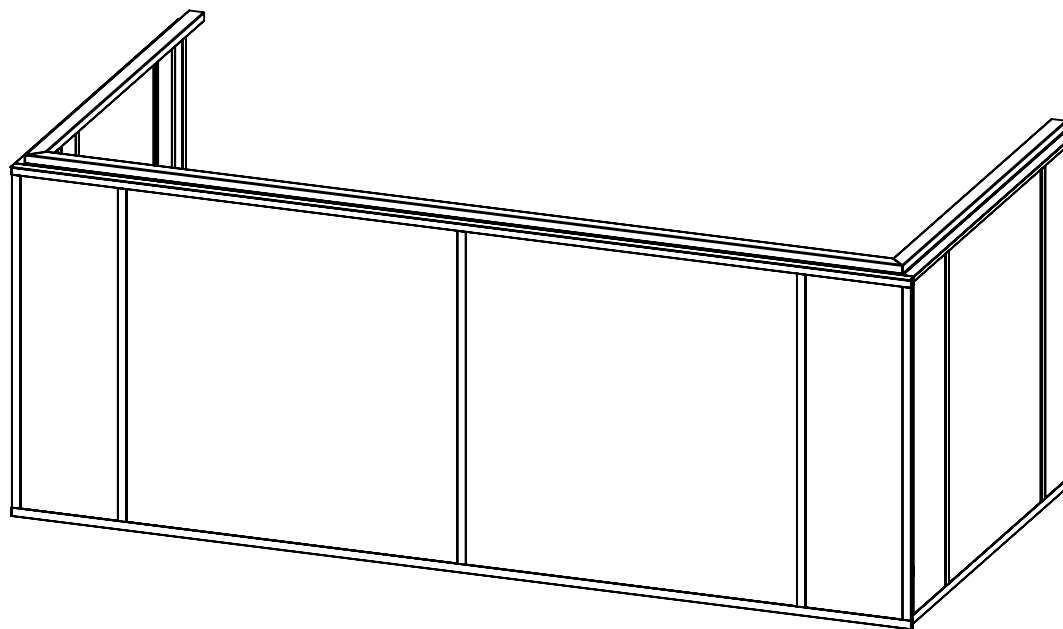
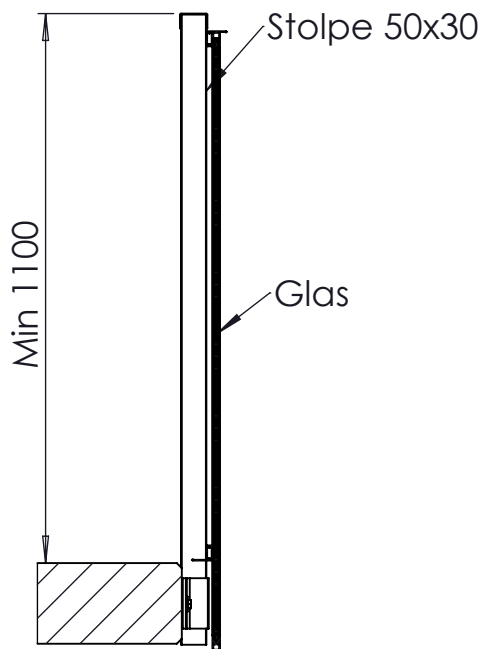
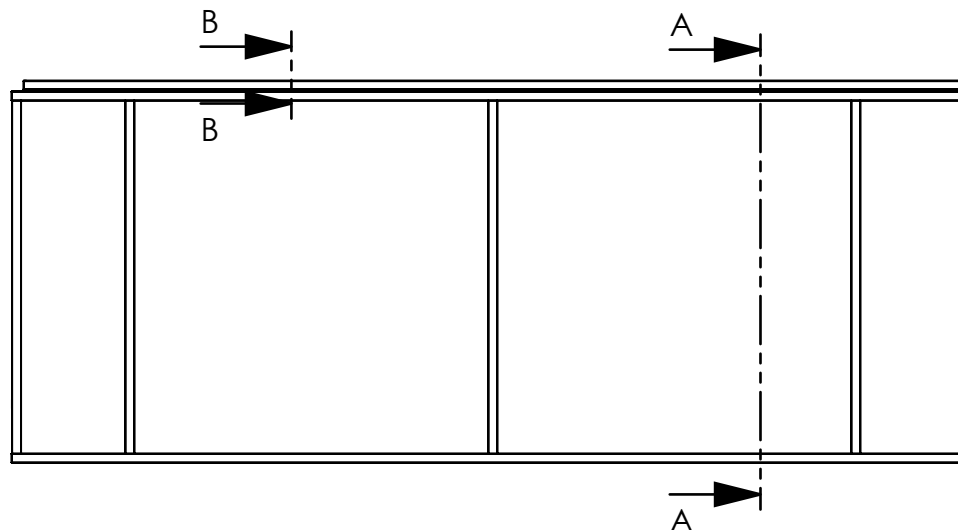
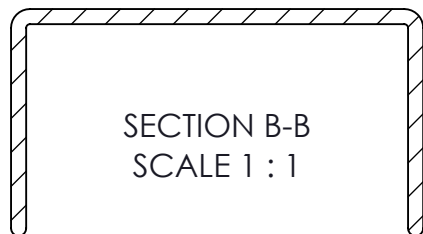

SECTION A-A
SCALE 1 : 15

Konstr. AK	Ritad AK	Kop. -	Kontr. -	Stand. -	Godk.	Skala 1:25	Generell tolerans SS-ISO 2768-m	
 RT400H Täckt plattkant							Ordernummer PRINCIP	Datum 2020-11-04
							Ritningsnummer 14008528	Rev.

Rev	Ant	Ändring och/eller medd.-nr.	Datum	Inf.	Godk.
-----	-----	-----------------------------	-------	------	-------



Konstr. EF	Ritad EF	Kop. -	Kontr. -	Stand. -	Godk.	Skala 1:25	Generell tolerans SS-ISO 2768-m			
						RT401 Täckt plattkant			Ordernummer	Datum
						Björnstorpsvägen 2 342 30 Alvesta Tel: 0472-44500				

Rev	Ant	Ändring och/eller medd.-nr.	Datum	Inf.	Godk.
-----	-----	-----------------------------	-------	------	-------